

GENERAL DESCRIPTION

DAB Pumps are proud to officially launch a brand new innovative product to the Australian market, leading the way in electronic pump technology. The E.SYBOX is a completely new solution in rainwater harvesting and cold water boosting for residential and light commercial applications. It's an all in one pump and control solution comprising of a single pump, water cooled booster pump with integrated high efficiency variable speed motor

But the E.sybox offers much more.... please see our commercial documentation for further details.

DESIGN FEATURES

- Water cooled motor and sound dampening casing creating the quietest booster pump available today
- Energy efficient variable speed motor operating from 0.3 KW to 1.5 KW
- Powerful performance Flow up to 2 Litres/second and head up to 6 Bar
- Self priming down to 8 Metres
- Dry running protection
- Frost protection
- Anti-vibration mountings
- Flexible installation with Horizontal or vertical position and wall mounting accessory kit
- Variable positions for in-let and out-let pipework
- Integrated chamber with expansion vessel, tool kit and installer manual
- Wireless connectivity and modular design can expand the pump system up to a 4 pump booster set (available end of 2013)
- Integrated modular water storage tank system with Cat 5 connection (available end of 2013)



Part No: DAB-E.SYBOX
Item Code: 800621

TECHNICAL DATA

MODEL	VOLTAGE	FREQUENCY	CONNECTION SIZE		ELECTRICAL DATA			
			SUCTION	DISCHARGE	MAX A	MAX POWER	PROTECTION CLASS	MOTOR CLASS
e.sybox	220-240 V / 1 ~	50/60 Hz	1" BSP F	1" BSP F	10 AMP	1550 W	IP44	F

PERFORMANCE

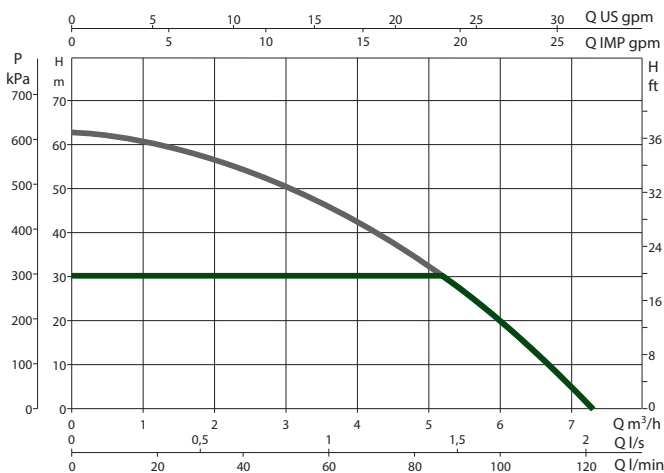

* DEFAULT SETTING

Maximum Flow: 120 Litres/Minute
Maximum Head: 65 Metres
Priming: 5 Mins at 8 Metres

OVERALL DIMENSIONS			WEIGHT EMPTY	MAX WORKING PRESSURE	MAX LIQUID TEMPERATURE	MAX WORKING ENVIRONMENT
L	W	H				
565 mm	265 mm	352 mm	27 KG	8 Bar	+ 40 °C	+ 50 °C

INTEGRATED SYSTEM PROTECTION INCLUDES:

- Protection against dry running (Auto & manual reset options)
- Antifreeze protection
- Anticycling protection
- Motor overload protection
- Protection against abnormal supply voltages
- Protection against excessive temperatures

See more about **e.sybox**
www.dabpumps.com/e.sybox



ESYBOX

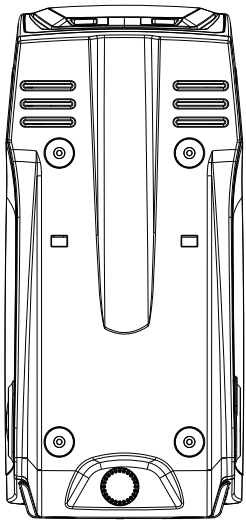

BOTTOM

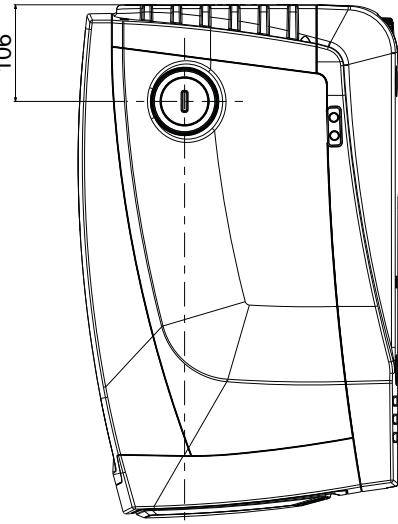

RIGHT

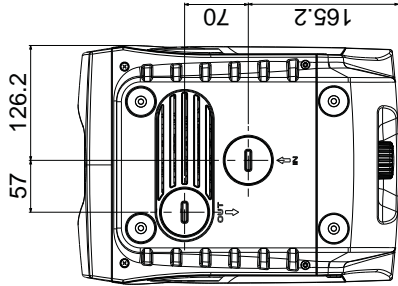

FRONT

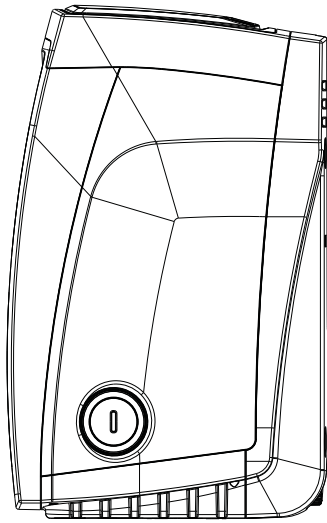

LEFT

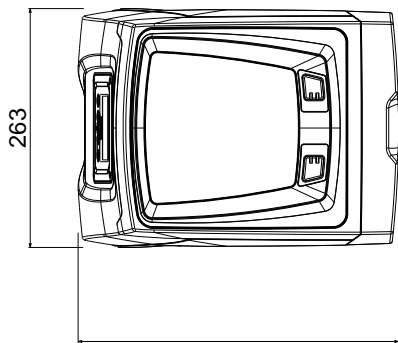

BACK

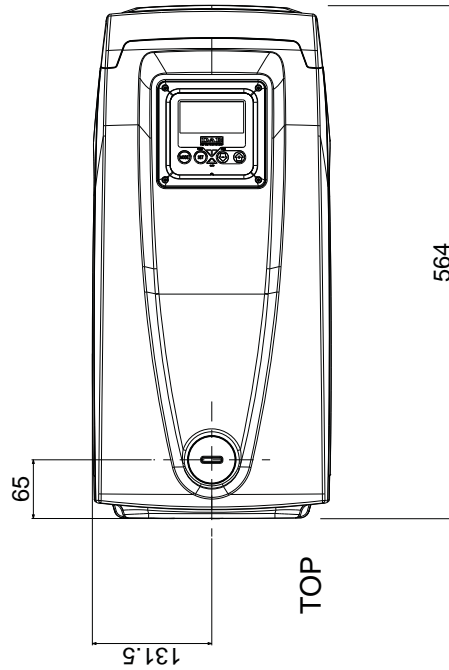

TOP

